

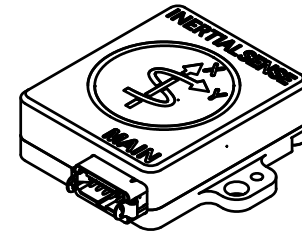

* POSITION OF IMU CENTER

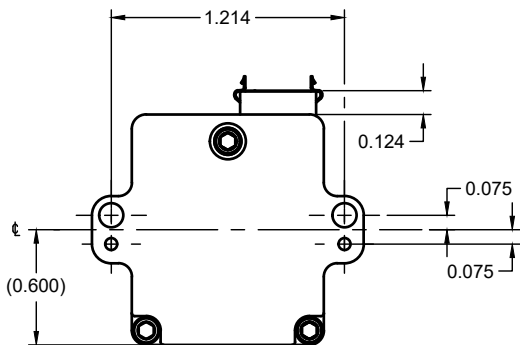

ACTUAL SIZE

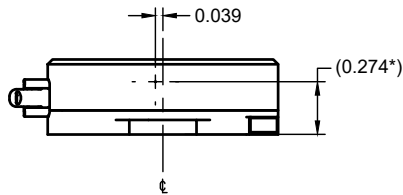
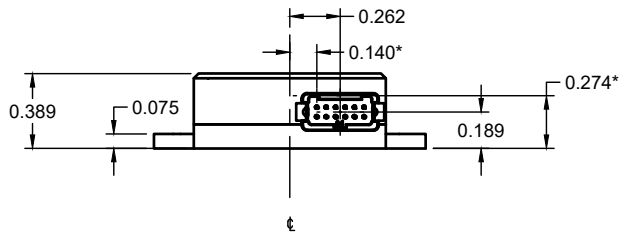
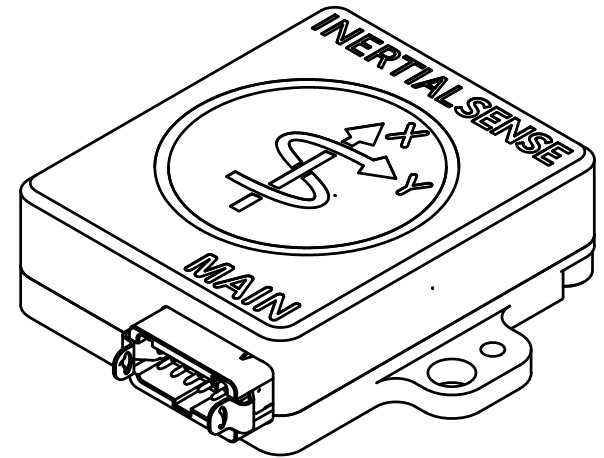

SCALE 2:1

 INERTIAL SENSE autonomous navigation solutions	PRODUCT RUG-3-IMX-5			
	PART INFORMATION P/N: IS-RUG-3.0-G0			
TOLERANCES UNLESS OTHERWISE SPECIFIED: <small>LINEAR DIMENSIONS: ±.005 ANGULAR DIMENSION: ±0.5°</small>		DIMENSIONS AND PINOUT		
ALL DIMENSIONS IN INCHES				
APPROVED	WALT JOHNSON	8/11/22	SIZE	MATERIAL
CHECKED	ANDREW PRIDDIS	8/11/22	A	DWG NO
DRAWN	ANDREW PRIDDIS	8/9/22	SCALE 1:1	WEIGHT
			IS-RUG-3.0-G0-PINOUT	REV
				1
			SHEET 1/2	

**"MAIN" CONNECTOR PINOUT
(ON RUGGED SIDE, NOT CABLE SIDE)**

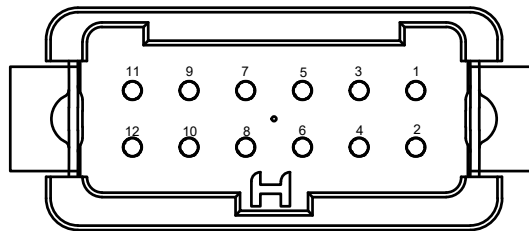

 <p>INERTIAL SENSE autonomous navigation solutions</p> <p>TOLERANCES UNLESS OTHERWISE SPECIFIED:</p> <p>LINEAR DIMENSIONS: ± 0.005 ANGULAR DIMENSION: $\pm 0.5^\circ$</p> <p>ALL DIMENSIONS IN INCHES</p>	PRODUCT RUG-3-IMX-5					
	PART INFORMATION P/N: IS-RUG-3.0-G0					
		DIMENSIONS AND PINOUT				
APPROVED	WALT JOHNSON	8/11/22	SIZE	MATERIAL	DWG NO	REV
CHECKED	WALT JOHNSON	8/11/22	A		IS-RUG-3.0-G0-PINOUT	1
DRAWN	ANDREW PRIDDIS	8/9/22	SCALE	WEIGHT	SHEET 2/2	